

User Manual

1390Laser Machine



1390Laser Machine

Dear Customers:

Thanks for choosing our 1390Laser machine. Please carefully read this instruction before using, which is helpful to you to use this machine well.



Our aim is continuously improving our existing products. So, maybe your machine is slightly different from the one in this instruction. If there is some changes, we will inform you by attached sheet. We regret any inconvenience. Please contact with our After-sale service department if anything is unclear, we will try our best to meet your requirement.



Because the I/O power, laser power supply and laser tube is electric, especially the positive pole of the laser tube, please be more careful when you operate the machine to avoid electric shock. Pay attention to the personal safety.

Copyright Statement

This instruction book is protected by Copyright Law, international copyright treaties and applicable laws. Do not copy any content of it without permission. Abiding by sustainable development principle, we may amend this instruction book when necessary without any notice.

The manual introduced how to install, use, process and maintain the laser engraving machine in details. Before unpacking, installing and using the machine, please pay attention to the following:

- ◆ The operator should have relevant technical training received, or supervised by specially-assigned person.
- ◆ The manual will help you to know and operate the machine.
- ◆ Many important tips in the manual will help you to operate and maintain the machine safely, economically and reasonably. If you could follow these tips, you can not only avoid the risks of accidents, lower maintenance costs, reduce downtime, but also improve machine reliability and lifespan.
- ◆ The manual should be kept near the machine for reference any time.
- ◆ The machine color in the manual is for reference, not related to the machine function.
- ◆ Safety requirements:

Improper using of laser tube will cause personal injury. Please learn about using laser safely before using to avoid injury, and to prevent the product or other connected products from damaging. To avoid possible danger, this product can only be used within the specified range.

- (1) Laser must not be pointed to human eyes. Even the laser is off, there is the possibility of being switched on mistakenly.
- (2) Laser is not a toy, do not allow children, mentally handicapped people, and the people who do not know about laser to use it, in such cases, danger may easily occur.
- (3) This type of laser is not visible, do not put flammable, explosive materials near the machine, to avoid risk of fire caused by laser deviation.
- (4) The laser is not visible, so we propose to wear special goggles when use the machine.
- (5) Product should be grounded. In addition to grounding the machine with power supply wire, to avoiding static electricity hurting, grounding wire must be connected with the ground. Before using, make sure that the product is properly grounded.
- (6) During machine working, machine top cover must be closed to prevent the injury by laser deviation.
- (7) Because there is laser and high Voltage inside the machine, it is strictly prohibited for non-specialists to disassemble machines without permission.
- (8) During machine working, the operator must always observe the working of machine (such as: cutting edge deformation or not, if the paper was blown high by air compressor and blocked laser or not, if the machine sounds abnormal or not, and temperature of circulating water, etc.). Operator is prohibited to leave the machine without authorization to avoid unnecessary losses.
- (9) Please don't switch on the machine when the voltage is unstable, otherwise you must use a voltage regulator.

- (10) The cooling water should be kept clean, and the temperature must not exceed 15 ~ 35 Celsius degrees (suggest high purity water).
- (11) Suggest that not to work with full load of laser power output, to avoid breakdown of laser power or even reduce the laser tube life.
- (12) laser power supply used in the basic constraints (that is, the maximum current meter can not exceed 35mA)
- (13) If there is some problem or caught fire, please cut off the power as soon as possible.
 - ◆ When meet suspicious problems, please do not operate. If there may be some problem with this product, please do not continue the operation, and request technician to check it,.
 - ◆ Don't operate in the wet condition.
 - ◆ Don't operate it in the explosive environment.
 - ◆ Keep the machine body dry and clean.
 - ◆ Reminding: Every machine-related staff should read this manual.

Operators: including personnel of assembly, troubleshooting of daily work, garbage removal, maintenance of machinery and waste disposal.

Maintenances: including personnel of maintenance, examination and repairing.

Contents

1390LASER MACHINE	II
I. SUMMARY	2
1.1 ADVANTAGES OF LASER PROCESSING TECHNOLOGY	2
1.2 TECHNICAL PARAMETER:	3
II LASER MACHINE STRUCTURE	4
2.1. STRUCTURE DESCRIPTION	4
2.2. SYSTEM COMPONENTS	4
(1) <i>Front side sketch map of the machine</i>	4
(2) <i>Sketch map of the control system</i>	5
III THE INSTALLATION OF LASER MACHINE	6
3.1. UNPACK THE PACKAGE CASE	6
3.2. POSITIONING	6
3.3 SKETCH MAP OF THE EXTERNAL POWER SUPPLY	7
3.4 LASER TUBE STRUCTURE AND INSTALLATION	7
3.5 LASER POWER SUPPLY INSTALLATION	9
3.6 WATER PUMP / CHILLER INSTALLATION:	10
3.7 INSTALLATION OF AIR COMPRESSOR OR AIR PUMP	12
3.8 EXHAUST FAN INSTALLATION	13
3.9 LASER SOFTWARE INSTALLATION	14
IV. STRUCTURE AND ALIGNMENT OF LASER PATH	14
4.1 STRUCTURE OF OPTICAL COMPONENTS	14
4.2 LASER PATH ALIGNMENT	17
4.3 HOW TO CHOOSE THE RIGHT FOCUS LENS (THIS METHOD IS SUITABLE FOR PROFESSIONAL TECHNICIANS)	20
V. CONTROL PANEL AND INTRODUCTION	22
5.1 SKETCH MAP OF THE CONTROL PANEL	22
5.2 SWITCHES	23
5.3 BASIC LASER MACHINE OPERATION PROCESS	23
VI PRECAUTIONS FOR USE AND MAINTENANCE	24
6.2 MAINTENANCE	25
6.3 LASER SAFETY GLASSES	27
7.1 NO RAY	27
7.2 THE LASER IS VERY WEAK.	29
7.3 THE ENGRAVING SURFACE IS NOT PLAIN	29
7.4 SPOTS SCATTERED, NOT FOCUSING, LENS CONE HEAT...PHENOMENA OF LASER ENGRAVING MACHINE.	30
7.5 SPARKING FROM THE EXIT OF LASER HEAD	31
7.6 WATER CHILLER ALARMING	31
7.7 X AXIS OR Y AXIS DOES NOT MOVE AROUND OR MOVE ABNORMALLY.	31
7.8 LASER HEAD OR BEAM SHAKING.	32
7.9 DIFFERENT ENGRAVING DEPTH OR COULD NOT ENGRAVE DEEP DEPTH	32
7.10 WRONG ENGRAVING AND NOT FOLLOWING THE FILE ENGRAVING	33
7.11 WRONG SIZE OR NOT CLOSING AND MALPOSITION WHEN ITS ENGRAVING	33
7.12 NO OUTPUT FROM THE COMPUTER	33
7.13 SOFTWARE ERROR ALERT INTERFACE.	34
7.14 COMMON PROBLEMS OF SOFTWARE	36
VIII. REGULATIONS OF REPAIR GUARANTEE	37
REGULATIONS OF REPAIR GUARANTEE	37

I. Summary

1.1 Advantages of Laser Processing Technology

Processing field is the largest field of laser technology application. Laser processing technology is a technology that using the interaction of laser beam and objects makes marking, cutting, welding, surface treat, punch, micro processing on materials, as well as the illuminant recognition objects. It has been a key technology of industrial production automation. The valuable features of lasers---good coherence, excellent monochromatic, perfect directivity, high brightness determines the advantages of laser in processing fields:

Laser as a processing method, no interactions between laser and work piece, with the advantages of no touching, no cutting force, small thermal effect, and no mechanical deformation, it ensures the original precision of the work piece. Also both power and speed of high energy laser beam can be adjusted, so can achieve the purpose of various processing, Meanwhile, laser is applicable to wide range of material types, so it can make high precision marks on surface of various materials and with very good durability.

1.2 Product Introduction

Laser engraving machine is a set of professional laser engraving equipment together with optical, mechanical, electrical. It is manufactured by our company. The key parts are imported components, with advantages of novelty appearance, unique structure, easy operation, high modulation frequency, fast speed, high precision, stable performance and so on. The application scope of laser engraving machine is very wide. Different designs have been used in machines of our company to meet the needs of all use. We believe that the type of machine you've chosen will surely be of great help to your work. The following introductions might provide you information for enlarging the scope of usage and to use laser machine well.

- Printing and packaging industry: rubber plate laser engraving, laser cutting of paper product, etc.
- Artwork and gift industry: bamboo slip laser engraving, wooden book laser carving, redwood laser engraving, double-colored plate laser engraving, box-shaped artwork laser engraving, chessboard laser carving, etc.
- Advertising industry: organic glass laser engraving (cutting), laser carving of all kinds of boards, double-colored plate laser carving, etc..
- Leather clothing industry: genuine and synthetic leather cutting and surface pattern engraving of different kinds of shoes and leather clothing, pattern engraving of all kinds of clothing and textile, etc..
- Model making industry: building model laser engraving (cutting), laser engraving (cutting) of aviation and navigation models, laser engraving (cutting) of cartoon figures, industrial model laser engraving (cutting), etc..

1.2 Technical Parameter:

Model	1390
Working Range Size	1300 mm×900 mm
Speed	0—60m/min
Laser Power Output Controlling	0-100% without interrupted
Cooling Mode	Water cooling
Resolution	0.025mm
Smallest Character Engraving	Chinese 2mm, English 1mm
Accuracy of Repetition	±0.01mm
Voltage	AC110V, 60Hz
Machine Total Power	2500W
Supported Graphic Format	BMP PLT DST AI DXF
Drive Mode	Stepper motor, divided driving
Laser Tube Power	180w
Operation Temperature	0°C~45°C
Operation Humidity	5%~95%

II Laser Machine Structure

2.1. Structure description

Complete working system is composed of machine of laser engraving, laser power supply, laser engraving software, exhaust fan and pipe, air pump, water cooling system, computer, communication` cable, etc. Printer, scanner, various kinds of designing software, etc. are equipped according to different machines being set up.

2.2. System components

This equipment is made up of five parts: mechanical platform, optical system, drive system, control system, and auxiliary system.

- ※ Mechanical platform: composed of machine cover, guide rail, base frame, reflecting mirror mounts, etc..
- ※ Optical system: composed of laser tube, laser power supply, laser head, three reflecting mirrors and one focal lens.
- ※ Drive system: composed of three imported high accuracy linear guide rails, step motors and several gears.
- ※ Control system: composed of high speed DSP control card, switching power supply and step motor drivers.
- ※ Auxiliary system: composed of circulating water cooling system, air pump and exhaust fan.

(1) Front side sketch map of the machine



(2) Sketch map of the control system

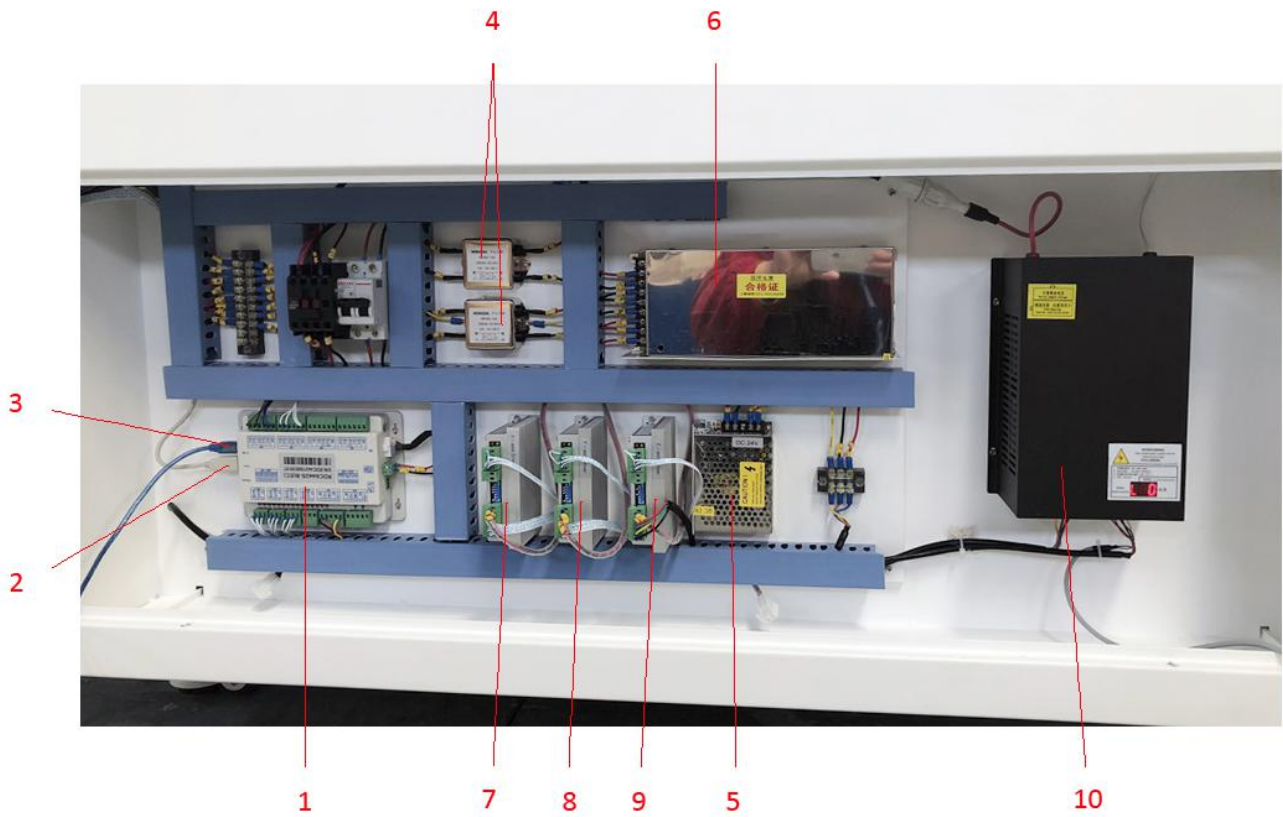

- 1. Laser controller board RD USB cable port
- 3. Cable connecting laser machine and computer
- 4. Filter
- 5. DC24V power supply, supplied for RDcontroller board
- 6. DC48V power supply, supplying power for the stepper motor drivers
- 7. Driver of X stepper motor
- 8. Driver of Y stepper motor
- 9. Driver of Z stepper motor
- 10. Laser power supply

III The Installation of Laser machine

3.1. Unpack the package case

After opening the packing box, please check whether there is any damage of laser tube or not. Then check the complete machine to see whether there is any scratch on the surface and the completeness of components/parts.

3.2. Positioning

The machine should be put in cool and dry places. It should be placed close to earth wire. After the machine has been adjusted, please don't move it again, otherwise the laser path has to be re-aligned.

After placing the machine, please fix the machine wheels and holders. if the machine shaking, please adjust the screws on the holder by making it up or down, tighten the nut after adjusting well, and make it stable. Structure diagram as follows:

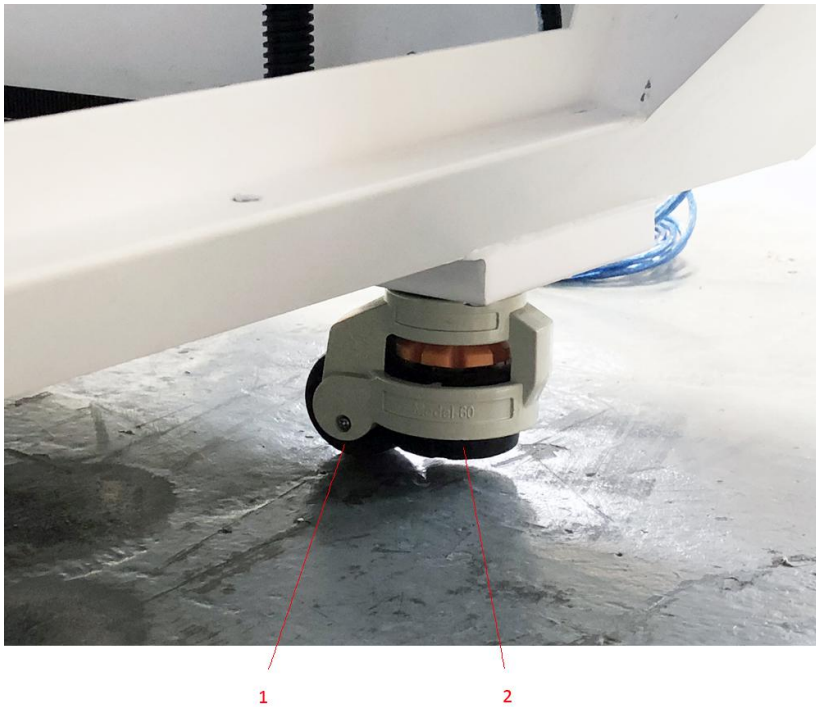

1. Universal wheel, can be moved in any direction, with brake..
2. Holder, height can be adjusted.



- Keep the machine flat when place it, fixed well every holder; the machine could not shake, or, engraving or cutting effect will be affected, even the machine may be damaged, user may be injured.
- The air humidity of the install place should not exceed 50%, and be well-ventilated

3.3 Sketch map of the external power supply

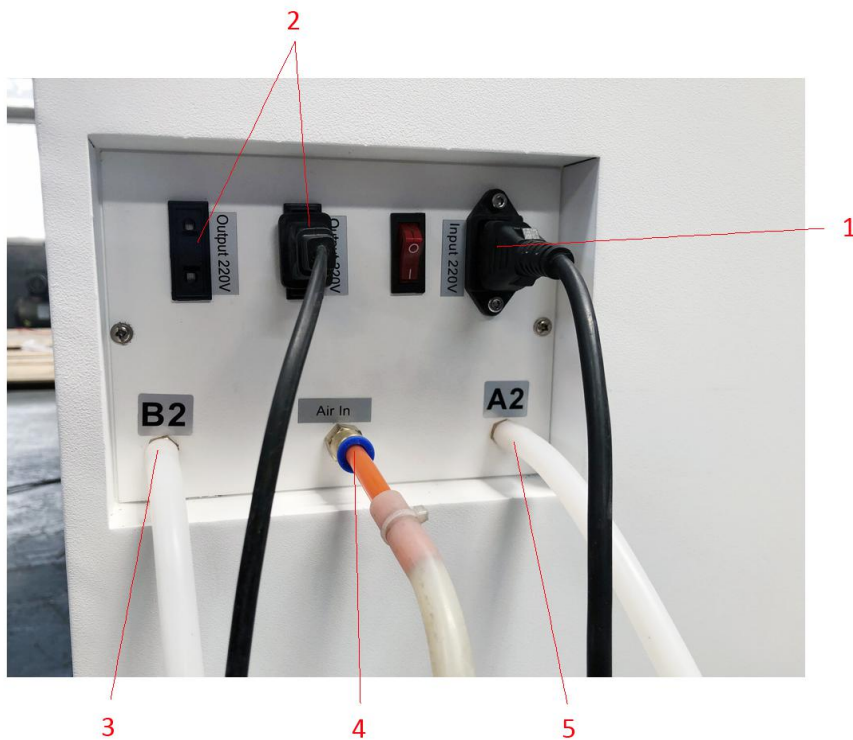

- 1. Main input power. It connects with AC220V.
- 2. Output power
- 3. Water outlet of laser tube
- 4. Air inlet
- 5. Water inlet of laser tube



- Be careful for the shock hazard! Sometimes an electric spark will be produced when you plug the power socket. Avoid electrical shock and to ensure personal safety.

3.4 Laser Tube structure and installation

- Laser tube is short of sealed CO₂ glass laser tube. It is the most important part of the laser equipment. Because the laser device is sealed by the glass tube, so it is called laser tube.
- Structure of the laser tube: it is the most important part of the laser equipment. Usually adopt hard glass and with layer structure. The most inside layer is power pipe. The second layer is water cooling pipe. The most outside layer for gas. The thickness of power pipe has none business with the output laser power, mainly considering for the diffraction effects caused by laser light spot, should be determined according to length of tube.

Longer tube will be a little thicker, shorter tube will be a little thinner length and output power is proportional. Within

a certain length scope, every meter power pipe increases the power as the length increasing. The two sides of power pipe connect with gas pipe, that is, there is one hole at one side for them to connect, at the other side connect via tracheal spiral. Then it could make the gas cycle between power pipe and gas pipe, and change the gas at any time. The function of water-cooled jacket is to cool the gas and make the output power stable.

- The model of laser tube is usually decided by laser power, the normal model is: 15W, 25W, 40W, 60W, 80W, 100W, 130W, 150W, 180W, 280W, 300W, etc..
- Laser tube with different laser power are with different length, such as 60w laser tube is 1200mm or 1250mm, 80w is 1600mm.
- Installation of the laser tube:
 - 1) The laser tube is glass material and fragile. Remove the screws with the allen wrench (in the toolbox), put the laser tube onto the two bases. The end of the laser tube which sending out laser (negative pole) should face to the first reflecting mirror. The distance between the side of the laser tube and the first reflecting mirror is 2~5cm. Fix the tube with the clips.

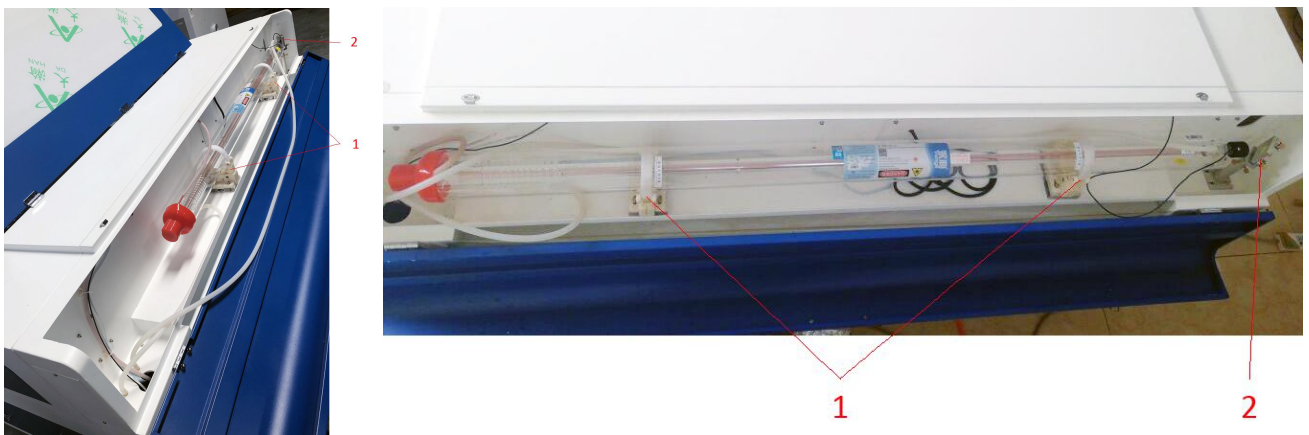

- 1 Clip ring for fixing the laser tube
- 2 First reflecting mirror

2) Installation of the pipes of water chiller

- a) Laser tube water inlet is at the positive end. The laser tube water inlet should be downwards and outlet pipe should be upwards. There should not be any leakage at the water inlet and outlet. Turn on the water chiller, check if there are bubbles in the tube after one minute cycling of the water. If bubbles coming out, please loose the clips of the tube and rotate the laser tube to extrude the bubbles.
- b) Inside the laser tube there should be no incrustation which would cause water stemming. If there is incrustation, please clean it with 20% diluted hydrochloric acid.



- The cooling water could not freeze, especially after the machine stop working. Make sure that there is no cooling water stay inside of the laser tube to avoid the crack generated by cooling water freezing.

3.5 Laser Power Supply installation

1) Laser tube wire installing:

Distinguish correctly the laser tube's positive and negative pole. Usually, laser light output end is negative (-), and the other is the positive (+).

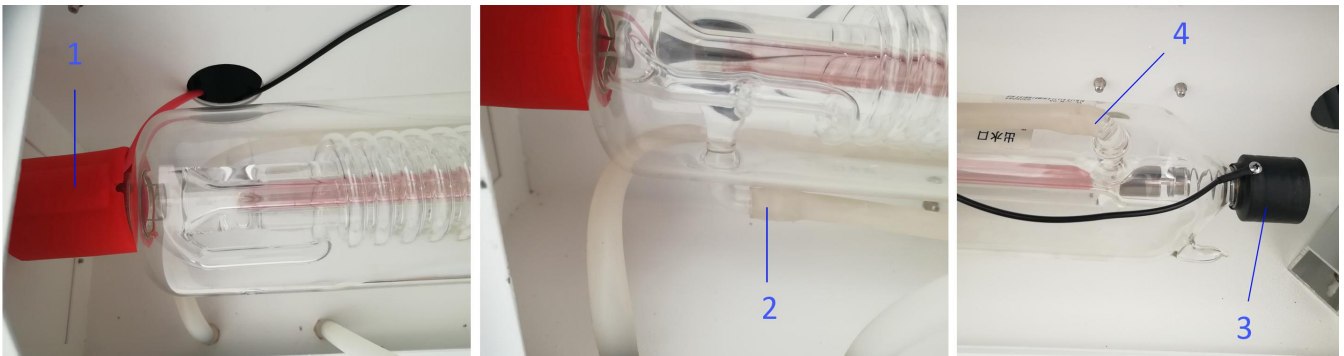
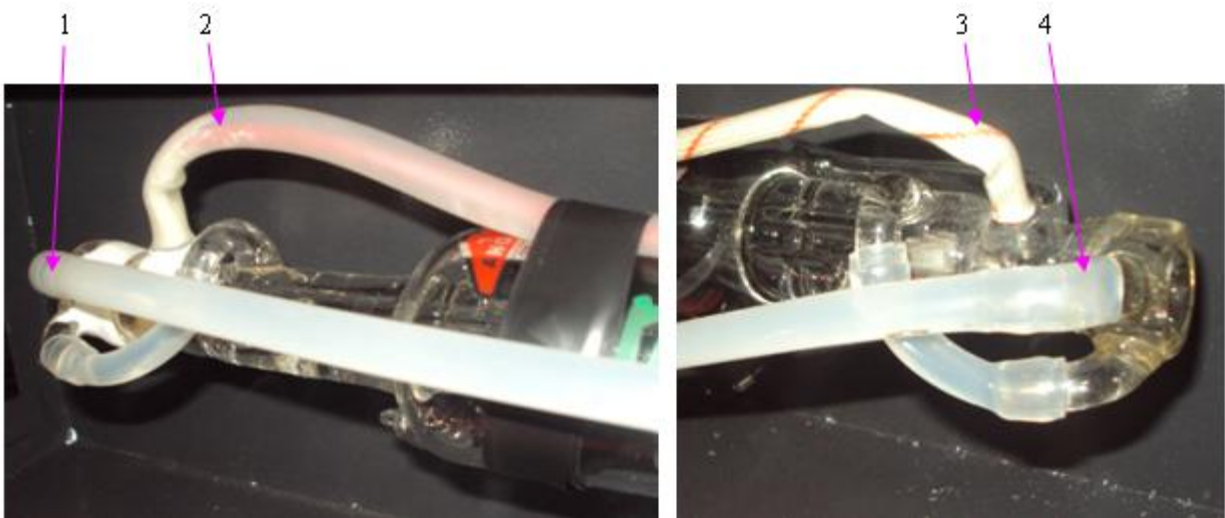

1. Positive pole (+) of the laser tube

2. Water inlet of the tube

3. Negative pole (-) of the laser tube

4. Water outlet of the tube



- Please note: the driving mode of the laser tube is high-voltage drive, and the work voltage is about more than 18KW. People not trained do not disassemble or assemble power. To avoid electrical shock, please discharge electrostatic before disassemble the power,
- Please differ the positive and negative poles, don't connect them reversely; or, the laser tube lifespan will be affected, even damaged.

3.6 Water pump / chiller installation:

Connect the rubber pipe with the laser tube and water chiller. The water chiller outlet connects to the laser tube inlet, and water chiller inlet connects to the laser tube outlet. After one minute of water circulation, please check out whether there is any bubble inside the laser tube. If there is, please rotate a little the tube to push the bubble out. Notice: Put the laser tube water inlet downwards, and water outlet upwards, there will be no bubbles inside the tube.

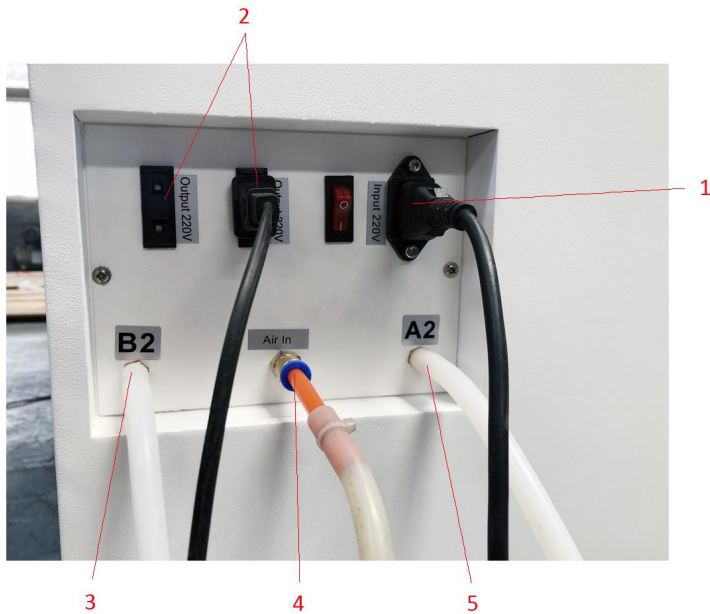

- 1. Main input power. It connects with AC220V.
- 2. Output power
- 3. Water outlet of laser tube, connects to water chiller inlet
- 4. Air inlet, connects to air pump or air compressor
- 5. Water inlet of laser tube, connects to water chiller outlet

Remarks: You can connect pipes according to labels on machine and water chiller.

Water pump (suggest to use water pump for laser tube 60W and below 60W)

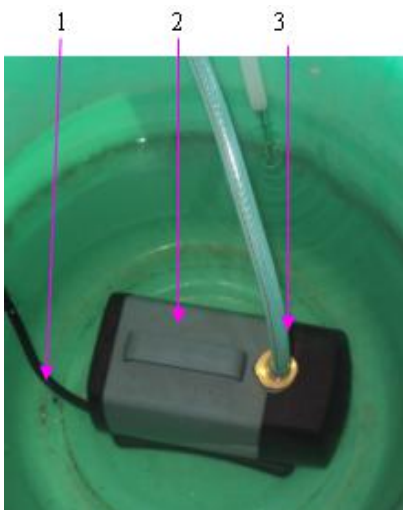

- 1. Power wire of the water pump;
- 2. Water pump;
- 3. Outlet of the water pump;

Water chiller (suggest to use water chiller for the laser tube higher than 60W)

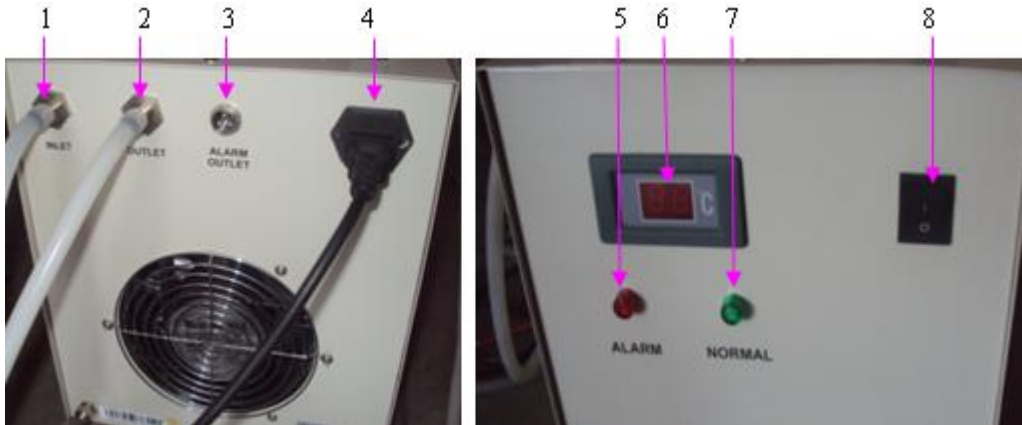

- 1. Inlet of the water chiller, usually connected with laser tube outlet;
- 2. Outlet of the water chiller, usually connected with the laser tube inlet;
- 3. Protecting line of water temperature for the water chiller;
- 4. Power wire of the water chiller;
- 5. Alarm indicator;
- 6. Temperature display screen for the water chiller;
- 7. Running indication
- 8. Power switch for the water chiller;

a) Requirements of the water in the water chiller: The water should be purified water or high purity water. The temperature of the water in the chiller should be 15°C-30°C. If the temperature is too high, please change the water or turn off the machine.

b) The flow of water should be 2L -4L/minute. If too much or too little, the laser dot quality and laser power will be affected. The chiller should be full of water, otherwise, the tube cannot be cooled well.

c) It is suggested the water in the chiller should be changed once a week.



- Propose to use water pump under 60W laser tube
- Propose to use water chiller for over 60w laser tube

3.7 Installation of air compressor or air pump

Instruction of air compressor (suggest use air compressor when cutting wood, MDF, die board, plywood etc.)

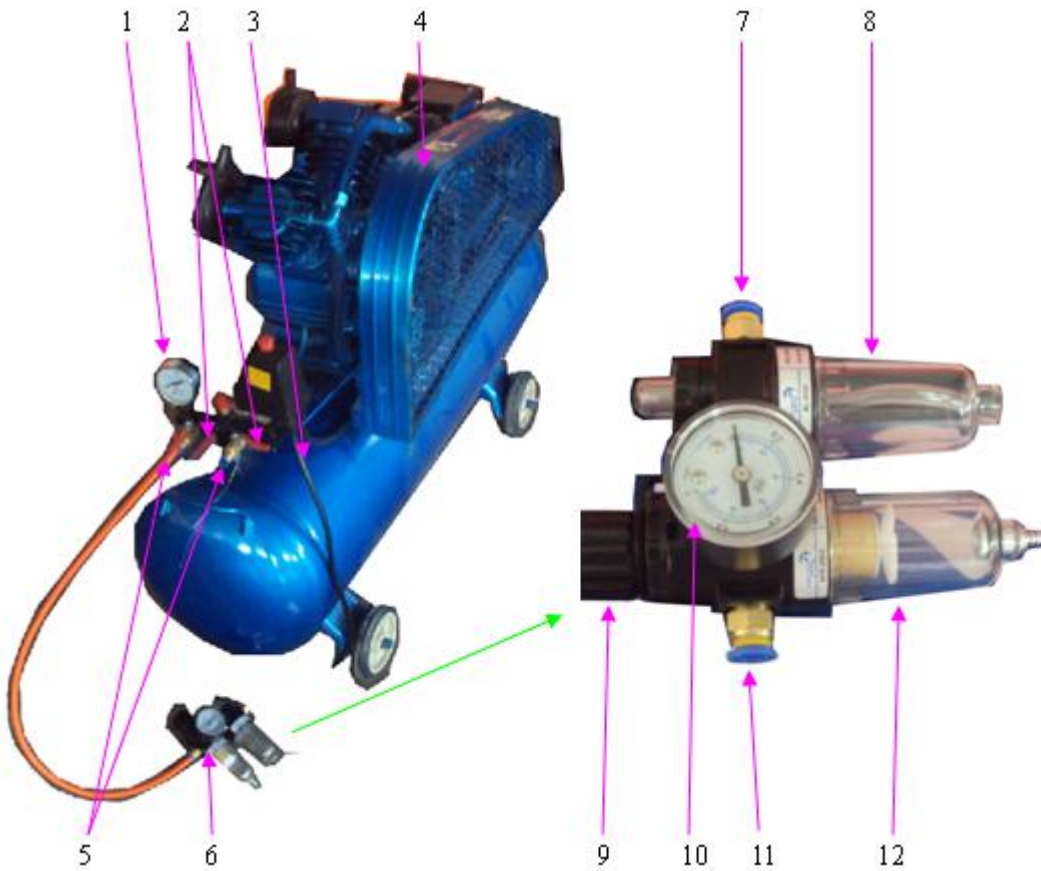

- 1. Air pressure indicator gauge
- 2. Air outlet control valve
- 3. Power line of air compressor
- 4. Air compressor
- 5. Air outlet of air compressor
- 6. Air filter
- 7. Air outlet of air filter
- 8. Oil filter
- 9. Air pressure adjusting knob of filter
- 10. Air pressure indicator gauge of air filter
- 11. Air inlet of air filter
- 12. Water filter

Instruction of air pump (Air pump is the standard air assist equipment)



- 1 air pump
- 2 air outlet of air pump

3.8 Exhaust fan installation

Connect the exhaust fan and machine with the air pipe. Turn on the exhaust fan.

After a long time use, the exhaust fan will be polluted with dusts, and makes loud noise, also not good for removing smokes and smells. When the exhaust fan suction is not strong and smokes cannot be removed easily, please first turn off the power, take off the wind inlet pipe and output pipe, remove dusts inside, and then put the exhaust fan downwards, pull the fans till they are clean. Finally install the exhaust fan.

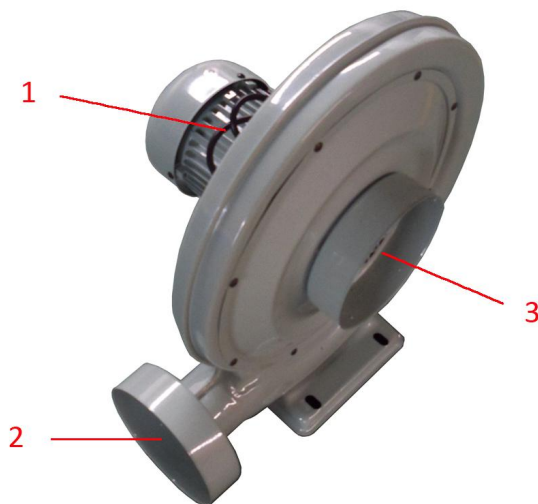

- 1. Exhaust fan
- 2. wind outlet of exhaust fan
- 3. Wind inlet of exhaust fan

3.9 Laser software installation

Please find the CD in toolbox. Put the CD in computer, run the software

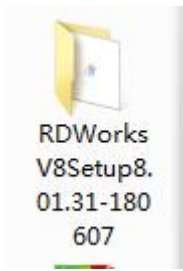

Double click on it to run.

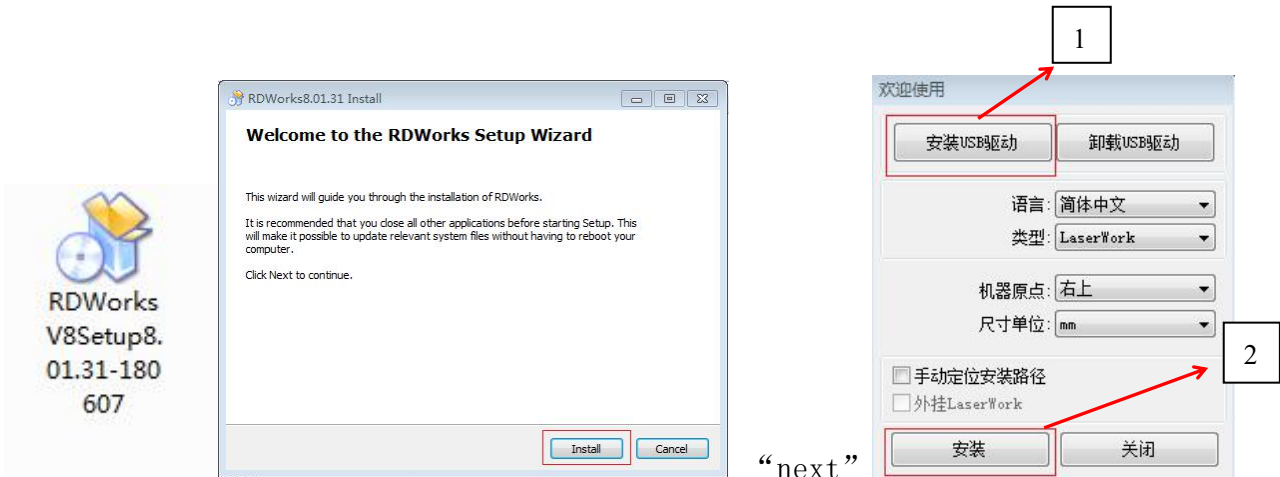

Install the software according to the instruction. First click “1” to install USB drive, and click “2” to install the laser software.



- Please use original CorelDraw or AutoCAD, or, laser software may have some running problem. We are not responsible of problems caused by using any non-original software.

IV. Structure and alignment of laser path

4.1 Structure of optical components

Laser path is the path where laser light goes through. The complete optical system is made up of laser tube, three reflecting mirrors, one focal lens and relevant adjusting devices. Laser path affects the effect of engraving and cutting greatly. Therefore please be patient and careful when adjusting and align the laser path.

Notice: Please be sure the cooling water circulation is good before the machine working, otherwise, the laser tube will be damaged.

(1) Sketch map of the mirror mounts

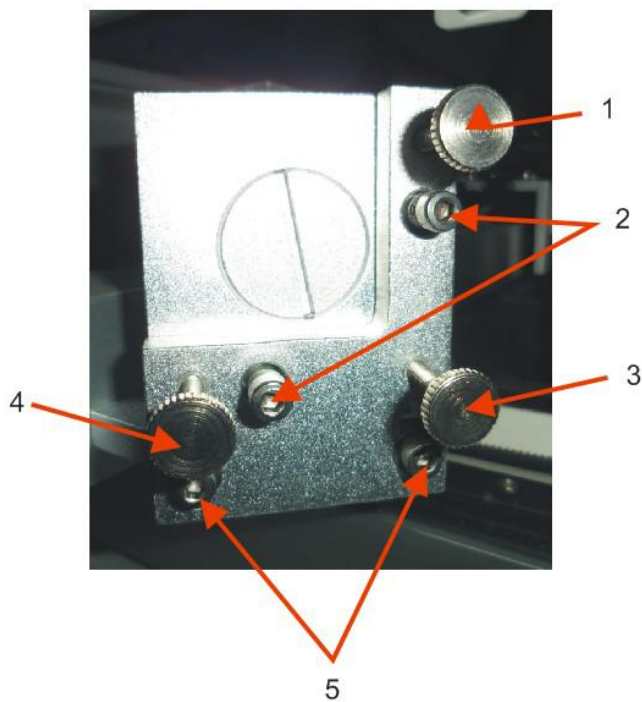

- 1. Laser ray adjusting screw for up - down direction. Only needs slight adjusting. When the screw is tightened, laser ray will goes down.
- 2. Fixing screw.
- 3. Adjusting screw for upper left - low right directions. When the screw is tightened, laser ray will goes to upper left.
- 4. Adjusting screw for left - right directions. When the screw is tightened, laser ray will goes to right.
- 5. Adjusting screw for up-down direction. It can adjust the laser ray direction up-and-down greatly.

Notice: When tighten both 1 and 3 screws, the laser ray will goes to left; when tighten both 4 and 3 screws, the laser ray will move up.

(2) Sketch map of the light guiding system:

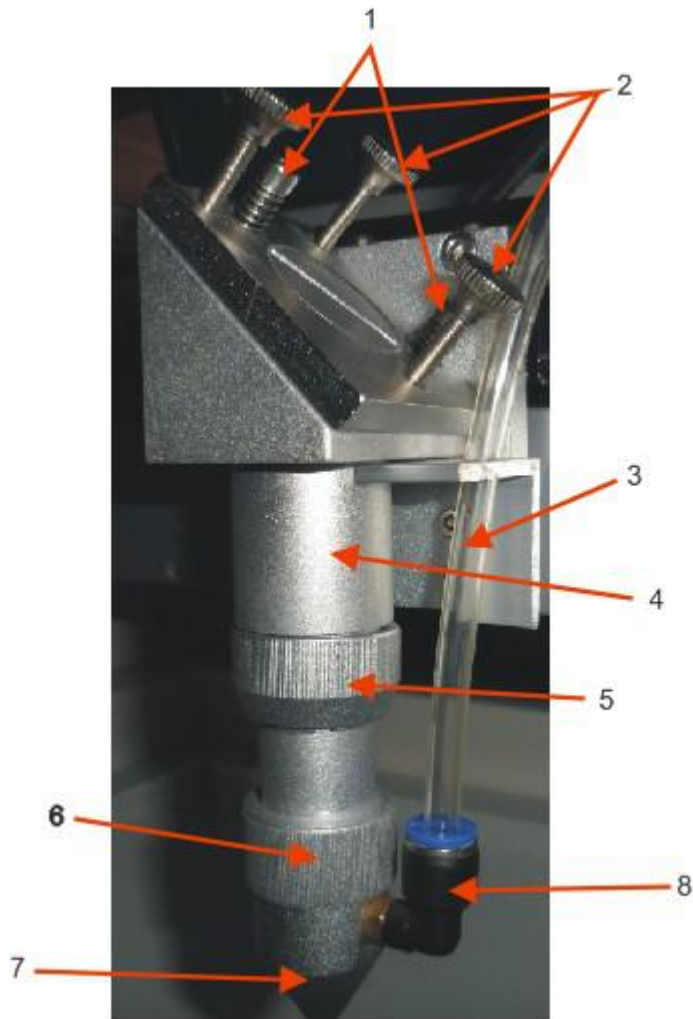

- 1 Fixing screw
- 2. Adjustment screw
- 3. Air pipe
- 4. Lens cone (top part), which cannot be removed.
- 5. Lock cap, which is used for moving up-and-down, and fixing.
- 6. Lens cone (bottom part), which holds the focal lens, and can be disassembled.
- 7. Laser head nozzle
- 8. Air inlet port.

4.2 Laser path alignment



- It is better wear gloves while adjusting the light path, in case the laser shoots your hands;

1. First make sure that laser beam from the laser tube shoots to the center area of the first reflecting mirror (the laser beam should be within $\pm 5\text{mm}$ to the center of the mirror). Put an acrylic or other transparent non-metal material in front of the first reflecting mirror (thus, we can see the reflecting mirror through transparent materials). Press “Pulse”, laser tube shoots laser, and leaves burned mark on the acrylic (laser testing dot). Observe the position of the laser testing dot on the mirror, then, adjust the laser tube position to make the laser dot get to the center of the first reflecting mirror.

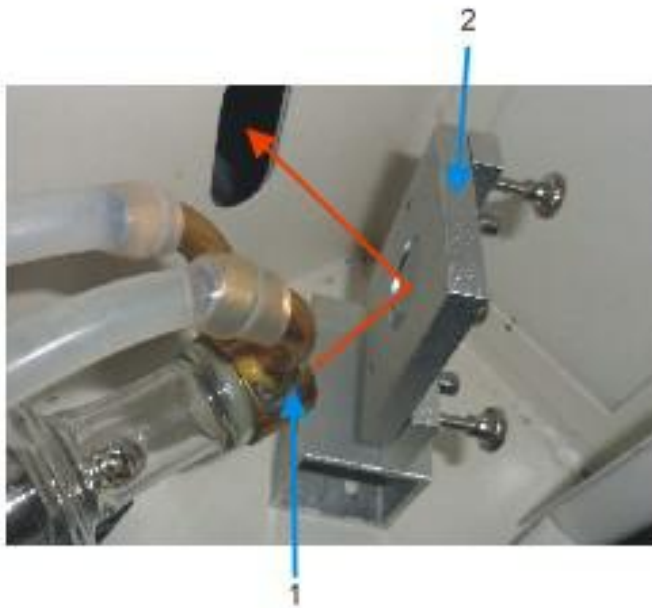

- 1. Laser light output port of the laser tube.
- 2. The first reflecting mirror.
- 3. The orange line is the laser path;

2. Adjustment of the first reflecting mirror

Put an acrylic or other transparent non-metal material in front of the second reflecting mirror, adjust the screws on the first reflecting mirror to make the laser light in the center of the second reflecting mirror.

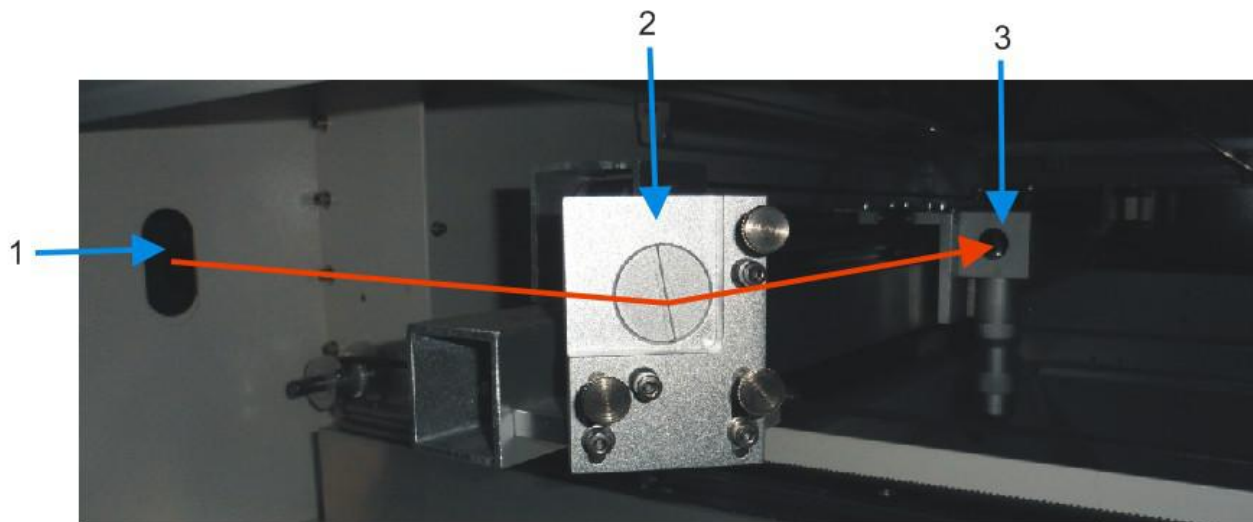

- 1. The exit for laser light after reflected by the first reflecting mirror.
- 2. The second reflecting mirror;
- 3. The third reflecting mirror;
- 4. The orange line is the laser path;
 - First step, move the laser head to the top left corner where the first and second reflector mirrors is nearest. Put an acrylic, paper or other transparent non-metal before the second reflecting mirror, press “Pulse” on the panel to make a laser dot on the material, adjust screws of the first reflecting mirror to make the laser dot in the center of the second reflecting mirror.
 - Second step: Stick a paper before the third reflecting mirror, press “Pulse” on the panel, move the X gantry back about 30cm, then the first and second reflecting mirror will be a little far, press “Pulse” on the panel and check if the two dots are totally coincident. If not, please adjust the first reflecting mirror to make the dots coincide totally.
 - Third step: Move the laser head to the top left corner where the first and second reflector mirrors is nearest. Stick a paper before the third reflecting mirror, press “Pulse” on the panel, Move the X gantry back about 60cm, then the first and second reflecting mirror will be further, press “Pulse” on the panel and check if the two dots are totally coincide. If not, please adjust the first reflecting mirror to make the dots coincident totally.
 - Fourth Step: Repeat the second step and third step until the dots coincide totally. (Move the X gantry every 30cm. Adjust the laser path at the distance between the first and the second reflecting mirror as 30cm, 60cm, 90cm ... till the whole machine table.)

3. Adjust the second reflecting mirror

- First step: put a small acrylic or paper in front of the third reflecting mirror. Move the laser head close to the second reflecting mirror, press “Pulse” and make a dot on the acrylic.
- Second step: move the laser head to the furthest position from the second reflecting mirror, and make a dot.
- Third step: If these two dots do not coincide, please adjust the screws in the second reflecting mirror to make these two dot in the same position.
- Fourth step: repeat the first and second steps, till these two dots gets to the same position.

4. Adjust the laser tube

- After adjusting the mirrors, the laser dots are coincide totally. But maybe they are not in the center of the mirrors. Then we need to adjust the laser tube to make the laser light get to the center of the third reflecting mirror..
- First step: Move the laser head to the top left corner where the first and second reflector mirrors is nearest. Put an acrylic, paper or other transparent non-metal before the third reflecting mirror, press “Pulse” on the panel to make a laser dot on the material to check if the laser dot is in the center of the third reflecting mirror. If not, adjust the laser tube (adjust the screw under the laser tube holder with 12*14 spanner) to make the laser dot in the center.
- Repeat laser path adjust step 1 and 2, to make all dots in the same position, and in the center of the third reflecting mirror.
- If the dot is in top area of the mirror center, please move the laser tube a little lower. If the dot is under the center, please move the laser tube a little higher. If the dot is on the right of third mirror center, please move the laser tube a little closer to the machine table. If the dot is on the left of the third mirror center, please move the laser tube a little further from the machine table. When adjust the laser tube position, please be carefully and move slightly, do not do it in a rush.

5. Test criterion

- First, all the laser dots are in the center of reflecting mirrors.
- Second, move the laser head to the four corners of the worktable respectively, all laser dots are coincident totally and in the center of the third reflecting mirror.



- Cut all power when adjust laser tube, to avoid risk of electric shock !
- Do not touch the positive pole of the tube when adjust laser tube, to avoid static shock !

6. Adjust the focal lens

Put a piece of acrylic on the machine table. Press “Pulse” button on the panel to see whether the piercing is vertical or not. If it is not vertical, adjust the screws in the third reflecting mirror till it becomes vertical and laser light becomes the strongest. Ray verticality adjusting is to make the ray perpendicular to the focus lens. Then adjust the focal distance. Unscrew the lock cap and move the laser head to adjust the distance from the lock cap to the material on the worktable, to make the engraving lines thinnest and deepest. When laser dots on acrylic are smallest and deepest, then, this distance is the best focusing distance for your machine. Remember this focusing distance for future use.

We prepare a focal length ruler (the stick in the following picture) for every machine. The stick size is the best distance between laser head tip to material surface. Keep it properly.

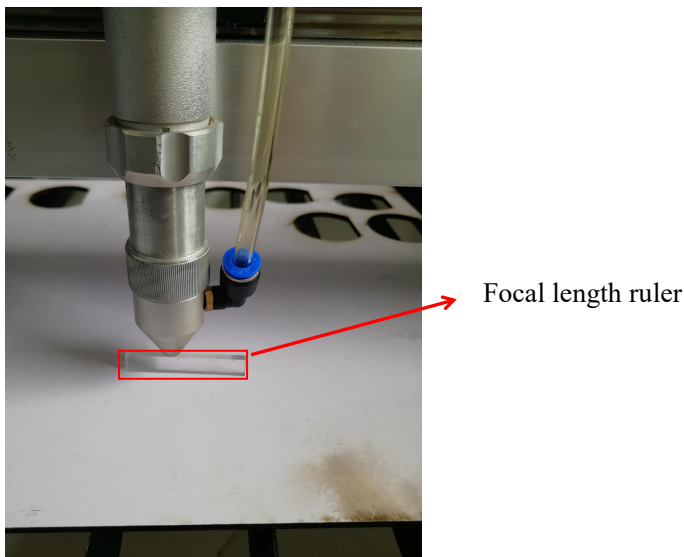

Notice: Laser path and focus distance affect the effect of engraving and cutting greatly. Therefore please be patient and careful when adjusting them.

4.3 How to choose the right focus lens (this method is suitable for professional technicians)

The direct cause of insufficient laser processing depth and processing speed: laser processing effective power density is small. For the same material, the laser processing effect depends on the optical power density (Note: not power) which is loaded on the material. Optical power density is the power per unit area, which is calculated as follows:

$$\text{Laser power density} = \text{power laser} / \text{laser spot area}$$

If you want to get a strong laser power density, when you cannot increase the power of the laser tube, you can

adjust the focal length of the focus lens to reduce the laser spot area, to achieve the requirement of laser power increasing. For most applications, reducing the laser spot area is more effective than increasing the laser tube working current or replacing higher power laser tube. Besides, cost is comparably lower.

- For the same laser beam, the relationship between the focusing length and focal spot size: the shorter the focusing length, the smaller the focus spot, and depth of focus is shorter; longer the focusing length, the bigger the focus spot, and depth of focus is longer. Focal spot size and depth of focus is a pair of contradictory. Depth of focus is the length of the laser power-intensive area of processing capacity after being focused.
 - Longer depth of focus is more favorable for processing thick materials, but this will make the focal spot larger, and cutting capacity decreases.
 - Smaller depth of focus is better for cutting capacity, but this will make the focal spot size smaller, and cutting thickness will be less. Meanwhile, it has stricter requirement for the machine table flatness, that is, it's sensitive to the unevenness of the machine table.
- Focus lens selection principle: If possible, use focus lens with short focusing distance. When the cutting speed cannot meet customer needs, please replaced with a shorter focusing distance focus lens. At the same time, it is recommended that customers prepare a variety of focus lens with different focusing distance to accommodate the processing requirements of different material thickness.
- The correct focusing mode should be: Refer to the focusing distance value of the focus lens, experiment several times near this value, and determine a point where processing capacity is the strongest, as the correct focusing distance for application. Even if it is the same lens, when materials and material thickness are different, the best focus spot position will also change. That is, for different materials and thickness, defocusing amount is different. Defocusing amount: the laser focusing process is that it first gathers and then diverges. In order to achieve the best cutting ability, the lens physical focal spot completely coincides with the surface of the material, but it may not be able to get the best processing result. Based on different situations, you should adjust the focus spot to a certain depth of the material, and get the best processing result, this depth value is the defocusing amount, whose value is related with material and material thickness.
- The above mentioned focusing mode is only for professional technicians.

V. Control Panel and Introduction

5.1 Sketch map of the control panel

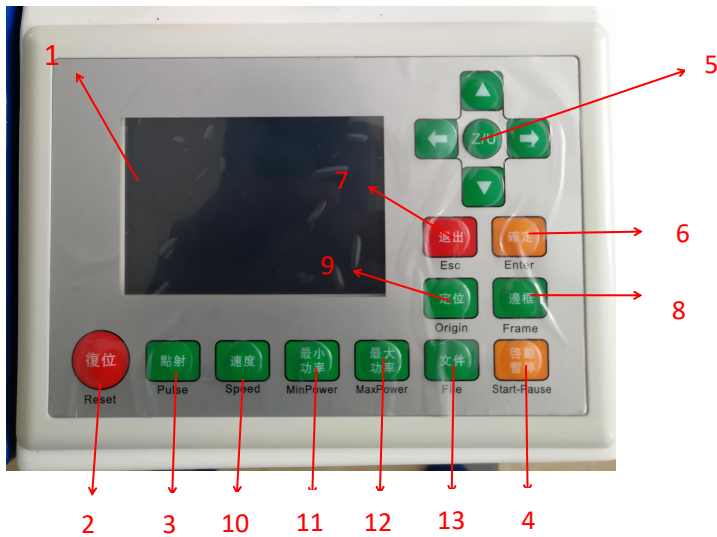

- 1. LCD display
- 2. Reset: the laser head will return to the original place in low speed; mainly for reducing the cumulative error. Ensure install the origin switch and input the switching signal into the control box;
- 3. Pulse: the laser tube will ray after pressed this button; it is used for testing the light strong or weak;
- 4. Start/Pause stops the laser head temporary while working; will go on work after press “Start”;
- 5. (1) Menu function button; (2) Z axis function: press this button, you can move Z axis by control the 4 direction buttons. This function needs equipment hardware support (optional up-down table)
- 6. Enter: when setting parameters, it confirms setting.
- 7. Esc: exit or cancel the function settings;
- 8. Frame: Without laser light, laser head runs the square of the file rapidly, mainly used for positioning.
- 9. Origin: set the start point of the file
- 10. Speed: set working speed
- 11. Min power: set minimum laser output
- 12. Max power: set maximum laser output
- 13. File: choose the file

Button function in laser software:

turn left

turn right

go forward

go backward

Frame: the outline frame of the engraving file

Laser: the laser tube will ray after pressed this button; it is used for testing the light strong or weak;

Stop: after pressed while working, the machine will stop working and returns to the original place;

Datum: laser head returns to the top right corner of the machine after pressed

Pause: stops the laser head temporary while working; will go on work after press “Start”;

The function on the panel is the same as that on the computer.

5.2 Switches

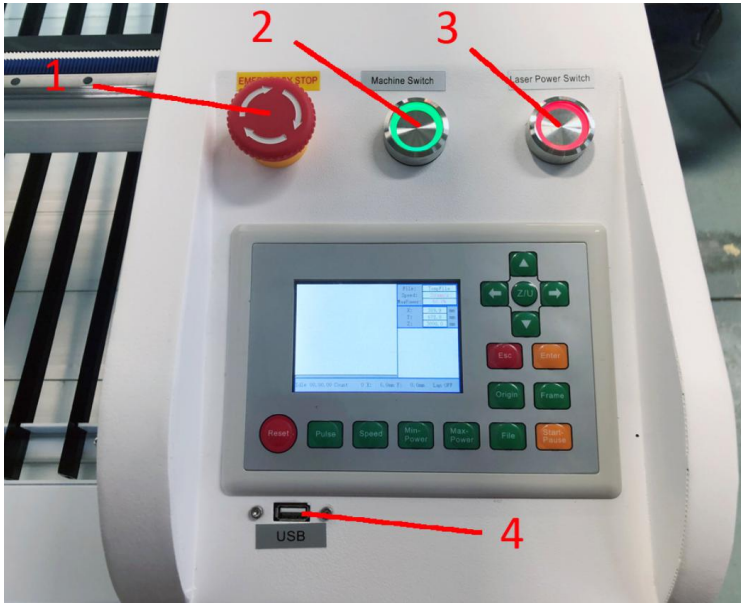

- 1. Emergency switch
- 2. Machine power switch
- 3. Laser power supply switch
- 4. USB port

5.3 Basic laser machine operation process

a. Turn on the laser machine

- 1) Turn on the water chiller. Then the water will flow to the laser tube. Please make sure the water have circulated more than 3 minutes before going on the following steps.
- 2) Turn on the machine switch.
- 3) Turn on the exhaust fan.
- 4) Turn on the laser power supply, press “Pulse” button on the panel to test if laser shoots.
- 5) Run the software, and press the 4 direction arrows in the software to test if the laser head moves.
- 6) Put the material on the machine table and adjust the focusing distance.
- 7) Operate computer, transfer file to machine and start engraving/cutting.

b. Turn off the machine

Turn off laser power supply, machine power switch, exhaust fan, water chiller and air compressor in sequence.

VI Precautions for use and Maintenance

It is more and more widespread application for the laser engraving and cutting machine, for customers (especially for customers who seldom use their machines), it is very important to be able to use and maintain well. We briefly outline on how to operate and maintain as below:

6.1 Daily operation cautions

- 1) Please do not stare straight at the laser light.
- 2) Operate the machine in the controllable area, and show warning signs.
- 3) People who have not been trained should not use the machine.
- 4) Close the space around the laser path in case the laser escaped;
- 5) Try to avoid the same height between the laser head and human eyes;
- 6) Pay attention to the ventilation and exhaust in the laser processing environment;
- 7) Check the water chiller to see if it can let the water out each time after starting the machine. It is forbidden to start the machine up when water cannot come out from the water chiller.
- 8) The water in the water chiller should be full. The water temperature should be about 15-35°C. If the temperature is too high, the water should be changed. It is better to use purified water so that there isn't any contaminant. Circulating water should be changed regularly (every week).
- 9) Because there is laser and high-pressure in the machine, non-professional workers should not disassemble the machine without authorization.
- 10) Reflecting mirror and focus lens should be wiped with special camera lens paper. Make sure the mirrors and lens are dry before using again.
- 11) Pay attention to the protection of laser light output window. Avoid smoke and dust polluting the laser light output window surface during working (and during laser path adjusting). Exhaust system must be equipped. If the output window polluted, laser power will be polluted. You can carefully clean the output window with cotton or silk cloth dipped in absolute alcohol

It is required that the grounding of all parts of the machine and user's computer should be safe to avoid damage of machine and injuries caused by static electricity.

- 12) Exhaust fan must be turned on while the machine working, so as to avoid pollutions on mirrors and lens.
- 13) Any irrelevant total reflection or diffuse reflection objects can not be placed in the equipment to prevent the laser

from reflecting on human body or flammable articles directly.

- 14) The water in laser tube should be drawn off in winter, in order to avoid frost cracking of the tube.
- 15) When the machine is working, operator must be watching the working, especially when engraving or cutting materials with high organic composition in high laser output power, in case of fire. People who haven't been trained are forbidden to operate the machine. Operators cannot operate against the operators should examine the working conditions (such as whether the laser ray has been blocked from shining on the paper used for crispening by the air coming from the air pump, unusual noise, temperature of circulating water, etc.) at any moment.
- 16) This type of laser is invisible, be careful during machine running. Do not put inflammable and explosive items near the machine.
- 17) The crossbeam cannot be pulled by hand. The machine should be put in places where there is no interfere and harmful effect of pollution, strong electricity, strong magnetism, and so on.
- 18) Power supply voltage: the laser will work unstable because of the fluctuation for the input voltage; if over tension, the power system will be damaged forever. So, please install a power stabilizer at least 5000W to avoid damaged by the device, circuit because of the voltage fluctuation, and also guarantee the stability.
- 19) Especially to the customer who is at the power-instability place, it is necessary to equip with power stabilizer.
- 20) Don't strike the keys and buttons strongly. Please press it lightly to avoid damages of those keys and buttons.
- 21) In case there is damage or fire, please turn off the power at once.
- 22) Please do not use the machine when the humidity is more than 80%, or it will affect the life the machine and damage the electronic parts.
- 23) Don't start the machine when there is thunder or lightning.

Users must be strictly adhered to the above rules; otherwise we are not responsible for any personal injury or machine damaged.

6.2 Maintenance

- 1). Replacement of water in chiller. (Recommended replace the water every week)

Notice: Before the laser tube working, please make sure water in the tube is full.

It is forbidden to use circulating water of poor quality, because it may affect the laser power seriously and shorten the service life of laser tube. The temperature of the water should be 15-35°C. If the temperature exceeds 35°C, please change the water(the right way of changing the water is to get out of some hot water and fill in cold water) or turn off the machine to cool the water.

2).Exhaust fan cleaning. After a long time, the exhaust fan will be polluted with dusts. Please open the box of the exhaust fan, remove the two pipes, and then get rid of the dust in the fan.

3). Optical mirror and lens cleaning. Users could clean the first mirror and the second mirror directly with lens paper or cotton plus medical alcohol to gently along the central to the edge be careful not to rub with a rough material or contact them. Please clean the reflecting mirror carefully when it is on the machine, otherwise, the ray path must be readjusted!

The third reflecting mirror and the focus lens need to be taken down from the laser head to clean. Unscrew the lens tube from laser head carefully, then blow away surface dust and gently wipe with the cotton dipped alcohol, put them back after cleaning. Before using the mirrors again, please make sure they are dry.



- Gently clean the mirrors, don't damage the surface coating.
- Handle with care while cleaning in case of dropping and damage.
- Don't clean lens and mirrors back and forth, or by rough materials. Because if the film on the surface of the lens and mirrors is damaged, laser power will be weakened;
- The absorbent cotton can be used for only one time. Please don't leave any cotton or residue on it; and start to work as the effect of the alcohol wears off

4).Guide rails should be cleaned, and lubricant should be added onto the rail every two weeks.

The materials for cleaning the rail: cotton cloth and lubricant oil

How to clean the rail : push the laser head to one end of the rail, and use the cotton cloth clean the rail, after that, add some lubricant oil on the different part of the rail, and then, push the laser head from one end of the rail to the opposite end, make sure the oil can be symmetrical added on the rail.

5). Tighten the screws and the shaft coupling

After a period of the time, the screws and the shaft coupling maybe loose, and this will affect the stability and mechanical movement of the machine. Tighten the screws and the shaft coupling every two or three months to make the machine work normally.

6). Bearing maintenance.

Using the soft cloth to wipe the dust which on the bearing, and then use the oil suction needle inject the oil into the bearing and slowly roll the bearing.

7). Laser tube maintenance.

The laser tube should avoid generating incrustation which would cause water stemming. If there is incrustation, please clean it with 20% diluted hydrochloric acid.

8). Light path

The light path is made of reflecting by reflector and focusing by the focus lens. The focus lens won't be skewing; but the skewing possibility of the three reflectors is high because of they are fixed by mechanical part. So we advice customers make sure to check up the light part before working.

6.3 Laser safety glasses

The laser machine belongs to class IV laser products. The laser is invisible to human eyes. Laser wavelength is 10.6 μ m (10600nm). The user must wear safety glasses when operate the machine. Please choose safety glasses according to the following requirements:

- Suitable for 10600nm wavelength
- Visible Light Transmission (VLT): 65%
- Have clear view without flickering
- Made of Hardened Polycarbonate, unbreakable
- High attenuation rate

VII. Regular failure and failure elimination

7.1 No ray

1. Did not turn on the laser power supply. The laser power switch is on the panel.
2. The laser path is not correct. It could also happen such situation when inclines large. Please refer to the previous section.
3. Check the ammeter state by pressing the testing key in the operator panel;
 - a) No current: check if the if the wires of the laser power supply, high-tension line and signal are connect well;
 - b) Current is available. Check if the mirrors or laser path is not correct;
 - c) Check the water circulation system works well or not;
 - d) Without water: check the water chiller is electrified or damaged;
 - e) With water: check the water inlet and water outlet if connected inversely or the water pipe is broken;
4. "Test light" button works well, but no ray when cutting or engraving. Please check if the signal cable is loose.
5. The laser power supply is broken, there are two ways,
 - a) The fan on the laser power supply should work after turning on the switch of the supply, otherwise the laser power supply is broken and need to be changed.
 - b) Check the electric wire of the laser power supply.
 - c) The following is the 200W laser power supply sketch map

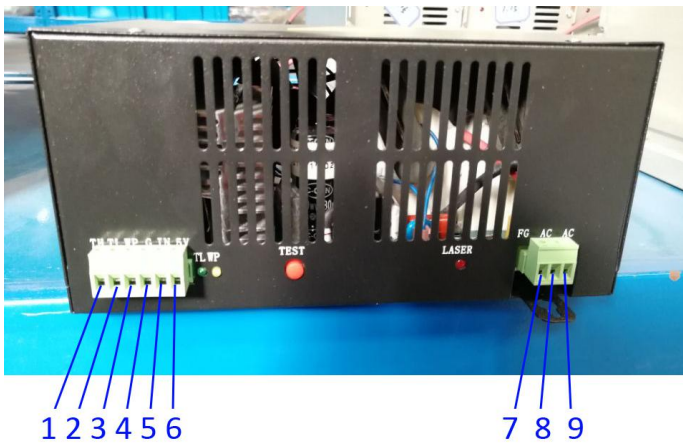

- Pin 1 is H (TH) input signal, which controls the optical switch, when the voltage $\geq 3V$, the signal will agree the laser tube to send out laser, when the voltage $\leq 0.3V$, the signal will not agree the laser tube to send out laser.
- Pin 2 is L (TL) input signal, which controls the optical switch, when the voltage $\geq 3V$, the signal will agree the laser tube to send out laser, when the voltage $\leq 0.3V$, the signal will not agree the laser tube to send out laser.
- Pin 3 is P (WP) input signal, which controls the optical switch, when the voltage $\geq 3V$, the signal will agree the laser tube to send out laser, when the voltage $\leq 0.3V$, the signal will not agree the laser tube to send out laser.
- Pin 4 is G signal. This pin connects the machine body and control card.
- Pin 5 is the IN input signal controls the laser power. It can be controlled by 0-5V analogue signal or 5V PWM signal.
- Pin 1 is 5V VOUT. The maximum current output is 20mA. If connect one resistor between pin 5 and pin 6, could enlarge the electricity and increase the laser tube power;
- Pin 7 is the ground wire of the laser power supply;
- Pin 8 is the negative electrode of the laser power supply
- Pin 9 is the positive pole of the laser power supply;

First, check if any signal from the PMC6535; when ray continuously, please test the high-level voltage input signal pin 1 and control signal pin 3 by multimeter (put the positive pole into the high-level voltage input signal pin 1, negative electrode put on the ground wire pin 4), to see the voltage in the multimeter. If the voltage is much less than 3V, then no signal provided from the MPC6535 board;

If no problem as above, test the water-cooling protect wire, short circuit the pin 3 and pin 4, to see if output while opening the laser (Do open the water chiller to cooling the laser tube when open the laser, or else will damage the laser tube); if ray, it means there is something wrong with the signal in water chiller; check the water-cooling protect wire if poor connected;

If no problem as above, check the socket of the digital line if connected well;

The pin definition of power wire (normal use for laser tube more than 100W)

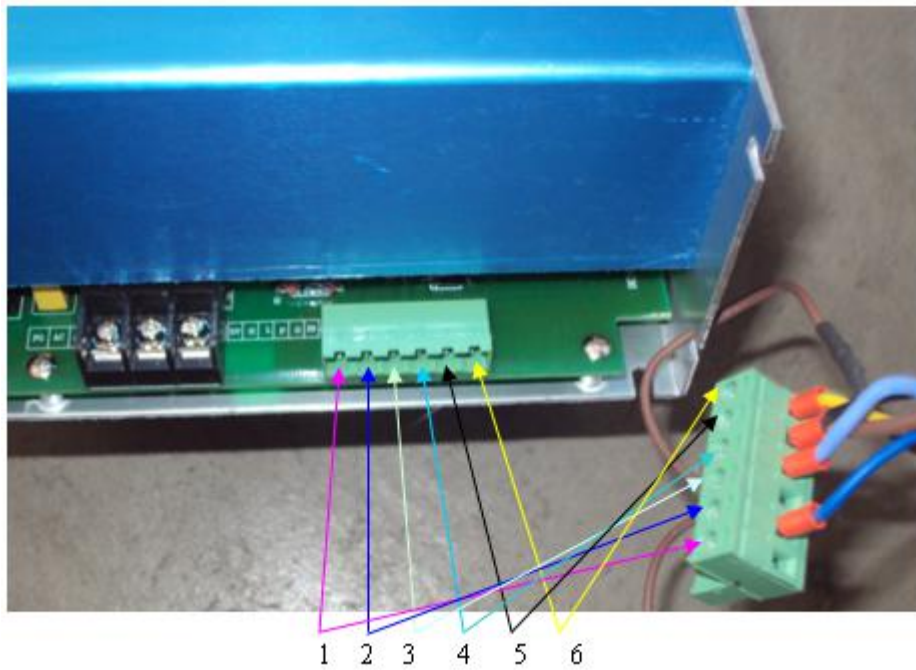

- Pin 1 is 5V VOUT. The maximum current output is 20mA.
- Pin 2 is H (TH) input signal, which controls the optical switch, when the voltage $\geq 3V$, the signal will agree the laser tube to send out laser, when the voltage $\leq 0.3V$, the signal will not agree the laser tube to send out laser.
- Pin 3 is L (TL) input signal, which controls the optical switch, when the voltage $\geq 3V$, the signal will agree the laser tube to send out laser, when the voltage $\leq 0.3V$, the signal will not agree the laser tube to send out laser.
- Pin 4 is P (WP) input signal, which controls the optical switch, when the voltage $\geq 3V$, the signal will agree the laser tube to send out laser, when the voltage $\leq 0.3V$, the signal will not agree the laser tube to send out laser.
- Pin 5 is G signal. This pin connects the machine body and control card.
- Pin 6 as the IN input signal controls the laser power. It can be controlled by 0-5V analogue signal or 5V PWM signal.

7.2 The laser is very weak.

- (1) The laser tube is too old. Need to change a new laser tube.
- (2) The focus lens is dirty. Take down and clean the focus lens.
- (3) The reflector mirrors are dirty. Take down and clean the reflector mirrors.
- (4) The laser path is not right. Adjust the laser path and make it vertical with the worktable.
- (5) The focus distance is wrong. Adjust the focus distance.

7.3 The engraving surface is not plain

Fault phenomenon: there is apparent spine phenomena while cleaning the bottom; when intaglio processing, there is apparent uneven phenomena In the place of rank crossed, when Yang Eagle processing, there is apparent spine

horizontal line between the place has character or no character; the deeper clean, the more apparent phenomena.

1. Failure cause

- (a) The speed is too fast. Please reduce the processing speed.
- (b) The flow of the air generated by the air pump is not steady. The powder is cumulate. Regulate the blowing of the gas, to ensure no powder adhesion, side-blowing is better.
- (c) The laser path or the focus distance is not correct. Adjust the laser path or the focus distance.
- (d) The focus lens is not suitable. Change the lens into short focal length lens.

2. Regular failure and obviate method

- (a) First, guarantee the light path is right by checking it
- (b) Lower the processing speed, increase the frequency of the laser output switch;
- (c) Adjust well for the gas well, to ensure no flour adhesion, it's better by side-blown;
- (d) Adopt the short focus Len, consider the processing thickness while adjusting the Focus Len;

7.4 Spots scattered, not focusing, lens cone heat...phenomena of laser engraving machine.

1. Fault phenomena: the laser beam machining can see yellow, and the rough beam diameter, hollow spot, when the hands touch the focusing tube, has a heat feeling.

2. Fault:

- a) water temperature of laser tube is too high.
- b) Lens pollution.
- c) Laser tube holder is unreasonable, which lead to the internal tube deformation.
- d) Ray path moved to one side, the focusing effect is poor, it is the main cause of focus drum heating and the sparking in the light exit of laser head.
- e) Lens is choose unreasonable, when adjusting the focus, not consider the depth of processing then caused the poor focusing.
- f) There is something wrong with the laser tube quality.

3. Exclusion method:

- a) Ensure that the water temperature in the laser tube is below 32 degrees.
- b) Adjust the ray path, make sure the ray path is correct and well, and consider the processing depth when adjusting the focus length.
- c) Ask our clients clean the lens and mirrors on time, make sure that they are not polluted; Choose the focus lens reasonably, and make sure the ray light is well.

- d) Check the position of laser tube holder, and adjust it to the right position.
- e) Change another new laser tube.

7.5 Sparking from the exit of laser head

1. Check the air blowing tube of the laser head if there is strong air current shoot up, because the air tube is too long and easy to be bended, blocked or worn out. Solving method: clean or change the white color air blowing tube.
2. Check the air compressor itself if there is something wrong, for example: the air-output is too small; or it doesn't work. Solving method: change a new air compressor.

7.6 Water chiller alarming

1. Firstly, ensure the power supply system normally. Low voltage is easily caused water chiller alarming. So we must make sure the voltage normal, if necessary, chooses the voltage stabilizer.
2. Check the water quantity in the water chiller, less water could cause alarming. Solving method: fill up pure water.
3. Check the water tube if it is bended or blocked, whether the water protection is blocked. Solving method: clean or straighten the water tube or water protection.
4. Check the water temperature; see if it is much higher than the limited value. Solving method: change the water often, or restart the machine to engrave after half an hour.
5. Check the inner of water chiller and see is there anything wrong with the water outputting, no water or less water. Solving method: Change a new water chiller.

7.7 X axis or Y axis does not move around or move abnormally.

1. Control card loosen or stoppage.
2. Limit switch or data line stoppage, check the limit switch, if it has signal, if the line connected well.
3. Drive of equivalent axis stoppage, check the drive supply electricity or not, signals is normal or not.
4. Servomotor of equivalent axis stoppage, check the connecting line of the motor short circuit or not, if it is abnormal, change a motor please.
5. Check whether the connecting line between motor and driver is loosen or connected well or not.
6. Check whether the coupling is broken or loosen.
7. Equivalent screw rod is broken or the screw of the screw rod stoppage.
8. Equivalent axis's slide rod stoppage.
9. Driver's subdivision, electric current are different from the software designed.

7.8 Laser head or beam shaking.

1. After power off, move the laser head and beam by hand, if there is obvious resistance, please check the left tensioning wheel, lead rail and slide block. Solving method: Clean the lead rail, slide block, changes the tensioning wheel.

2. Check whether the laser head and air blowing tube are locked or not, whether the beam is shift too much or not. Solving method: adjust the beam, straighten the air blowing tube.

3. Push the laser head, check if there is a fricative or shaking. If yes, that is because the space of the slide block is too large, so change another slide block.

4. Check whether the motor and driver is connected well or not.

5. Check the transportation parts of the machine (coupling, shaft block, screw of the screw rod, straight line bearings and slide block), whether they are loosen or broken, reasonable assembling (loose or tight).

6. Start the machine, check which axis shaking, laser head or beam. Cut off the supply of one axis, check the other axis's motor and driver, if there is stoppage. Interchangeable test, find which axis' motor or drive the problem is. If there is any stoppage, change another one in time.

7. Reset in the right direction, but in the end, the laser beams can not stop or crash the machine. So we need to check the parameters of motherboard, whether sensor dust is excessive or not, the sensor cable is disconnected or the sensor is damaged.

8. If the problem still exists, may be motherboard failure, contact with the factory replacement motherboard.

7.9 Different engraving depth or could not engrave deep depth

1. Check whether the water circulation system is smoothly flowing (water pipes bent or broken);

2. Check whether the focal length is normal, if the focal length is wrong, please adjust the focus.

3. Check whether the laser path is right, if so, please adjust the laser path again.

4. Check whether the mirrors or lens are dirty, if so, please clean them.

5. Check whether the lenses are broken, if so, please change new one.

6. Check whether the outside of the laser tube is dirty, if so, please clean it.

7. Check whether the worktable is plain.

8. Check whether the X-axis cross girder is parallel.

9. Check whether the temperature is higher than 30°C (change the water for cycling)

10 Check whether the laser head or Focus Len is loose (fasten them)

11. Check whether the laser tube is aging (change it; free changing within guarantee time)

7.10 Wrong engraving and not following the file engraving

1. Initialization is not correct, the data was sent out (please make a change)
2. Operation was not in order(need to key in again)
3. Control card problem
4. The configuration number of the software was problem
5. The driver fault or current subdivision numbers setting was different with the software.
6. Inverter interference or wire problem.
7. Electrostatic interference

7.11 Wrong size or not closing and malposition when its engraving

1. Edited files is it correct (reset again)
2. Select filed is it out from the size of the layout (choose again)
3. Please check with the parameter of software is it right(set again)
4. To the belt left and right, check if the tightness degree are consistent. If the synchronous belt is too loose, the performance will appear double image for engraving letter; if too tight, will damaged to the synchronous belt. Please adjust the synchronous belt if there is something wrong with it: adjust the screw to suitable degree, no double image for engraving letter and low noise while running the machine.
5. Check the belt or synchronous belt is slip or Jumping over Teeth (fasten the synchronous wheel or belt)
6. Please check the beam is it parallel.
7. Please check the pulley at the laser head is it abrade, that's made the laser head not hard up, that must need to change a new pulley.
8. Please check the computer system is it right (please installation the software again)

7.12 No output from the computer

Please check with the parameter of software running is it correctly(reset again)

1. When the laser machine was running, is it fixed position as first or not, after that can output the data(reset the output)
 1. Please check is it not datum when its starting the job(reset again)
 2. Please check the output gorge is it same as software setting.(reset again)
 3. Please check the earth line is it stable, and the static electricity is it interference the wire(make the earth connection again)
 4. Change the gorge and texting the output

5. Please installation again for the laser software and texting again
6. Please formatting the computer system and installation the software again and texting again.
7. Please check the main board gorge is it damage, if its please repair or change a new one.

7.13 SOFTWARE ERROR ALERT INTERFACE.

The operation panel can real-time display the alert interface, which cause by various improper operation or external disturbance signal. According to the information which display on the panel, it is easy for the user to correct the wrong operation, and exclude the external disturbance signal.

1. Soft limit stops

When found this kind of error, it show that the work scope data, which input into the computer is bigger than the real worktable.

Solution :

Remove the laser head, and make it in the scope of the worktable. Another way is that conceal the “immediately output order “reset the proper data again, and then download the data.

2. Hard limit stops

When the user operate the machine while does not make the laser head back to the original point. It is easy cause that the processing area is bigger than the real worktable and when the laser head bump into the “size control signal “ the movement have to cease.

On the other hand, when the machine in a complex environment which have a lot of interference signal, it will also display this kind of information.

Solution :

Remove the laser head, and make the processing graphic data in the scope of the worktable.

When we find the alert information while the laser head does not bump into the “size control signal “ so we can sure, it is caused by the external disturbance signal. When we meet this kind of situation, please check the ground cable

3. Lack of memory space alarming

Reasons:

- a)The number of download files is more than the total number of Memory device—32
- b) The download files is too big and exceed the Memory device

Solving Method:

Make sure that the download files not exceed the total memory of Memory device. Remove the files that we don't need, release the memory space.

4. Configuration and firmware mismatching

Reasons:

After firmware updating, not download the configuration and file to match with this firmware.

Solving method:

- a) Open the installation catalogue of application procedure, operate version testing procedure, check if the function library match with firmware version, if not match, please contact with the supplier to get a matching function library.
- b) Double-click application procedure, download configuration.

5. The error of function baseband firm ware mismatching

Reason for this error:

The function base for making processing file mismatch with firm ware.

Solving method:

The version number of controller for movement is not visible for change, unless to upgrade this controller via “firm ware loading”.

6. Hardware and firm ware mismatching

Reason for this error:

After upgrading of the firm ware, hard ware doesn't support the new one.

Solving method:

- a) Please copy the new firmware file (FM.FMW and 05201.HDW two files) to the root directory of U-disk (formatted as FAT16, we propose that U disk do not have any other files)
- b) Break off the power of MPC6515/35, insert U disk and then connect power for MPC6515/35, the light D1 on MPC6515/CPU main board flash 2 times fast and D1 is always on (usually 2 to 5 seconds, depending on the firmware), firmware is being updated at this time; if U disk with lights, following the instructions of U disk to observe whether it is reading data via the flashing light, 6535 plate could be judged by observing light on U disk;
- c) D1 on MPC6515 main board flashing quickly, indicating the updating of the firmware finished ; if U disk with lights, follow the instructions to observe whether the reading of the data finished via flashing lights, It is about 15 seconds;
- d) Extract U-disk, MPC6515/35 will normally start DSP firmware program. If MPC6535 can not work normally when U-disk extracted, maybe a firmware need to be updated. So repeat the steps to update the firmware. If MPC6515/35 still can not work normally, contact distributor.

7.14 Common problems of software

1. When engraving with gradient, double phenomenon

This phenomenon occurs when the slope of words carved smaller, usually the reason is "wide" setting slope too large, cause calculation errors, please set "wide" little slope.

2. If you only can move a graphic with one direction, please click "Shift" or "Ctrl" to recover.

3. PLT format cannot to engrave

There are two reasons, one is the graphic is not closed, the other is graphic double.

Please detect this phenomenon with "data detect" tools

4. The size is not same with engraving/cutting samples.

Open the item" laser machine set", adjust the pulse

5. The edge is irregularity when engraving

The edge is irregularity maybe happen when you use the DSP5.3 engraver software,

that means "burr", this is mainly caused by mechanical return clearance, this is the solution

a) Draw a box (rectangular or square), set work mode for the laser carving, the sculpture is 0.5 mm instead, then see engraving effect, theoretically, should be aligned, namely the odd interlaces did edge should be aligned, even did edge also should be aligned, only the odd and even did not have a little.

b) When you open" set engraving parameters", the parameters for different engraving speed can be seen, the reverse gap is"0",you should adjust it as the matter of fact.

c) You can chose" single-track light" when best engraving effect needed. Not to chose the draw of "dual-engrave", but when you chose it, the efficiency would be lower.

6. The X-axis or the Y-axis not move (MPC6535)

a) Stir knob to chose the DC 5V, test the voltage between PULX (or PULY) and GND. Take Y axis as example, click the button of 'up' or 'down', the normal voltage is 2.8V, if it is not, we could confirm the controller was broken, please change the controller. If it is, please go to next step.

b) Exchange the output terminal of the two drivers, then press "Up" or "Down" button; if X axis works normal, it means there is something wrong with the motor on Y axis, please change a new one; if X axis doesn't work, it means there is something wrong with the driver on Y axis, please chance it;

7. X Axis and Y Axis work in only one direction;

a) Test the voltage between the DIRX and GND after pressed the multimeter into grade 5V; take the X Axis for example, press "left", then press "right" to see if there is some change on high level (>2.8V) and the low level(<0.8V); if not, the control card is broken and need to change a new one; if with change, please check the driver

if works normal;

b) Please change the driver on Y Axis;

8. NO ray;

Test the voltage between the LAS and GND after pressed the multimeter into grade 5V; press “fixed fire” in the control panel, to see if there is some change on high level ($>2.8V$) and the low level ($<0.8V$); if not, the control card is broken and need to change a new one. Also set up the time of fixed fir as 0 millisecond, which is in the PAD03 menu.

Adjust the power from 0%~100%, enter and press “fixed fire” button, then test if any change between the DA1 and GND from 0V to 5V; if not, the control card is broken, please change it; if both with, it means there is something wrong with the laser power supply.

VIII. Regulations of repair guarantee

We are responsible for the repair of complete machine for one year. Guarantee of laser tube (we are not responsible for blowing out of laser tube caused by high water temperature and frost cracking caused by low water temperature), mirrors and lens is three months, accessory parts is six months.

Regulations of repair guarantee

1. Within the guarantee period, our company will provide service for problems that appear in normal using conditions for free. (This point is valid only for domestic customers. Certain amount of maintenance fees will be charged by the company when offering service out of China.).
2. Certain amount of maintenance fees will be charged by the company when the guarantee period is over.
3. Our company will not provide maintenance and repair for free in circumstances that the sealing paper is damaged caused by disassembly of the machine without authorization, the machine is not used in correct way, problems caused by calamities of nature and calamities imposed by other people, or the customer can not show us the repair guarantee certificate of the product.
4. It is very important to keep the serial number of the product given by the manufacturer when the product leaves factory. Only when information contained in it has been confirmed, can customers enjoy after-sale service provided by our company.
5. The manufacturer has the right to modify specifications of the product without notification to customers in advance.
6. The manufacturer only undertakes legal responsibilities for his products sold to customers, but is not responsible for other losses caused by problems of the machine or indirect compensation responsibility. The manufacturer will

not take any compensation responsibility for loss of commercial profits, service interruption or any other monetary loss caused by the use or abnormal use of the product.

7. This certificate will be valid only after being stamped by distributor. It will be invalid if altered.